

# 1 凹型花纹产品结构图

BW(mm) 带宽	CW(mm) 花纹最窄	CW(mm) 花纹最宽	CP(mm) 花纹间距	PA(mm) 带边宽	CH(mm) 凹花纹	最宽模具 mm	模具
0-1600		1150	85mm		2	1700	



## 2 人字型花纹产品结构图

BW(mm) 带宽	CW(mm) 花纹宽	CP(mm) 花纹间距	PA(mm) 带边宽	CH(mm) 花纹高	DW(mm) 花纹上宽	模具宽度 mm	模具 1
	1600	150		5		1700	
BW(mm) 带宽	CW(mm) 花纹宽	CP(mm) 花纹间距	PA(mm) 带边宽	CH(mm) 花纹高	DW(mm) 花纹上宽	模具宽度 mm	模具 2
	1600	95	0	6		1700	
BW(mm) 带宽	CW(mm) 花纹宽	CP(mm) 花纹间距	PA(mm) 带边宽	CH(mm) 花纹高	DW(mm) 花纹上宽	模具宽度 mm	模具 3
	1480		0	8		1500	
BW(mm) 带宽	CW(mm) 花纹宽	CP(mm) 花纹间距	PA(mm) 带边宽	CH(mm) 花纹高	DW(mm) 花纹上宽	模具宽度 mm	模具 4
	1200		0-150	10		1400	
BW(mm) 带宽	CW(mm) 花纹宽	CP(mm) 花纹间距	PA(mm) 带边宽	CH(mm) 花纹高	DW(mm) 花纹上宽	模具宽度 mm	模具 5
	1200			15		1400	



### 3 八字型花纹产品结构图

BW(mm) 带宽	CW(mm) 花纹宽	CP(mm) 花纹间距	PA(mm) 带边宽	CH(mm) 花纹高	DW(mm) 花纹上宽	模具宽度 mm	模具 1
800-1300	750	220	0-250	15		1490	
BW(mm) 带宽	CW(mm) 花纹宽	CP(mm) 花纹间距	PA(mm) 带边宽	CH(mm) 花纹高	DW(mm) 花纹上宽	模具宽度 mm	模具 2
750-1300	725	298		4.5	35	1495	
BW(mm) 带宽	CW(mm) 花纹宽	CP(mm) 花纹间距	PA(mm) 带边宽	CH(mm) 花纹高	DW(mm) 花纹上宽	模具宽度 mm	模具 3
	600	100		15			
BW(mm) 带宽	CW(mm) 花纹宽		PA(mm) 带边宽	CH(mm) 花纹高	DW(mm) 花纹上宽	模具宽度 mm	模具 4
	380			15		830	

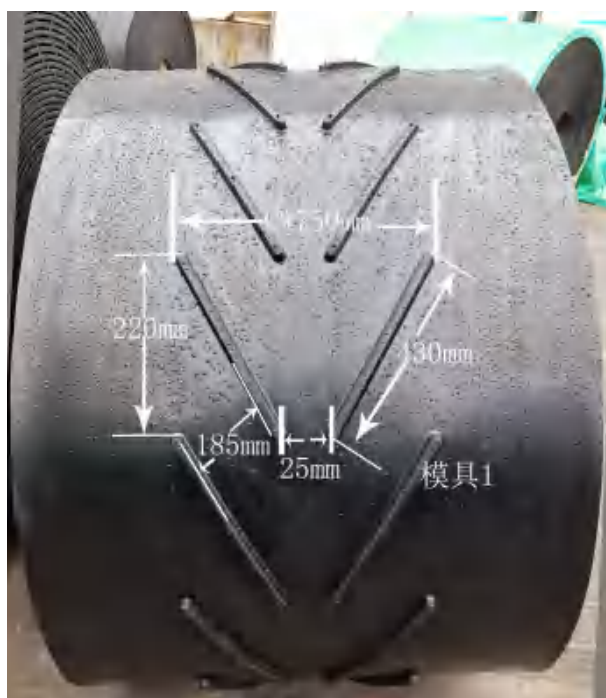

## 4 U 型 CH25mm 花纹产品结构图

BW(mm) 带宽	CW(mm) 花纹宽	CP(mm) 花纹间距	PA(mm) 带边宽	CH(mm) 花纹高	DW(mm) 花纹上宽	EW(mm) 花纹下宽	模具 1
500~800	450	225	0~300	25	15	25	模具 2
800~1400	750		0~600	25	15	25	
BW(mm) 带宽	CW(mm) 花纹宽	CP(mm) 花纹间距	PA(mm) 带边宽	CH(mm) 花纹高	DW(mm) 花纹上宽	EW(mm) 花纹下宽	模具 3
600~800	550		0~250	25	15	25	

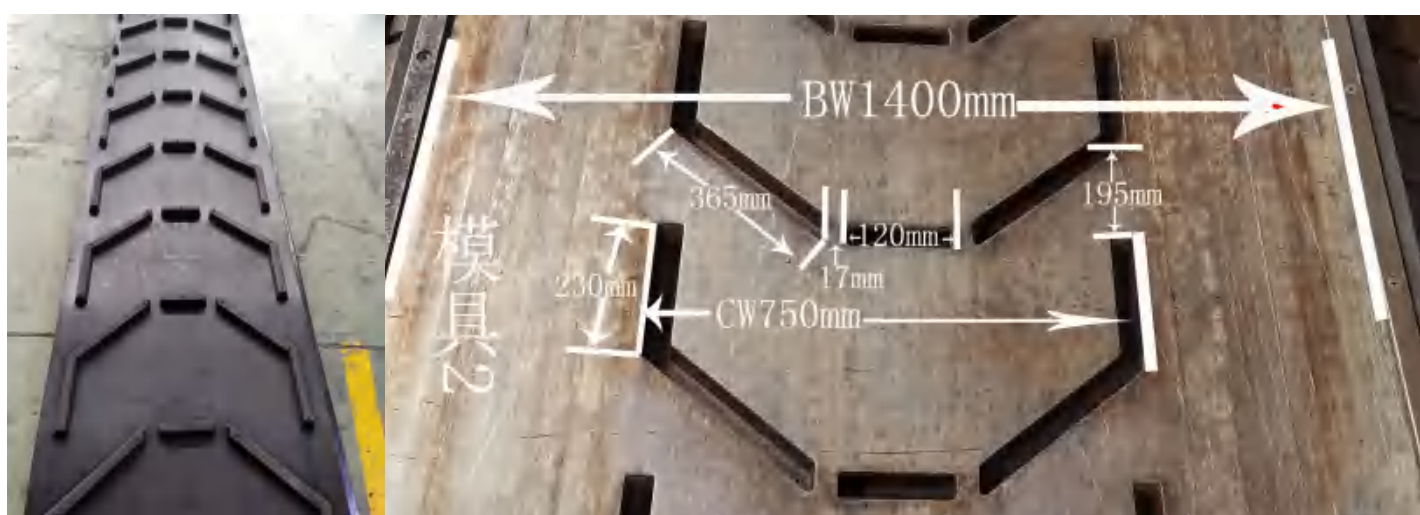
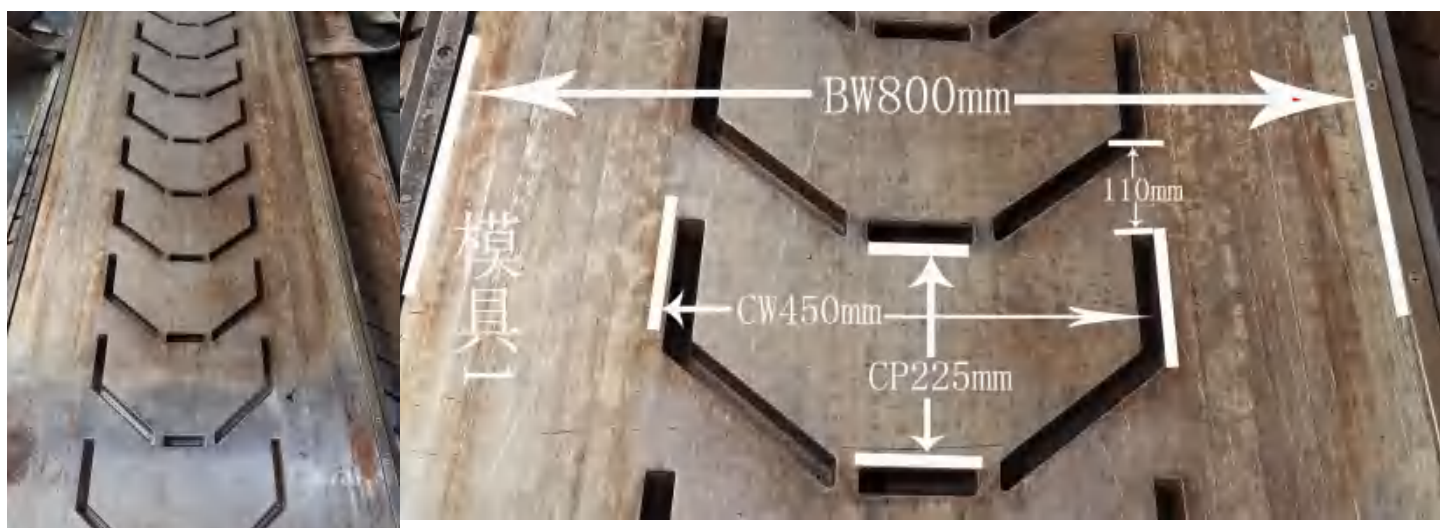

## 5 U 型 CH15mm 花纹产品结构图

BW(mm) 带宽	CW(mm) 花纹宽	CP(mm) 花纹间距	PA(mm) 带边宽	CH(mm) 花纹高	DW(mm) 花纹上宽	EW(mm) 花纹下宽	模具 1
600~800	550		0~250	15	15	20	
BW(mm) 带宽	CW(mm) 花纹宽	CP(mm) 花纹间距	PA(mm) 带边宽	CH(mm) 花纹高	DW(mm) 花纹上宽	EW(mm) 花纹下宽	模具 2
800~1300	750		0~500	15	15	20	

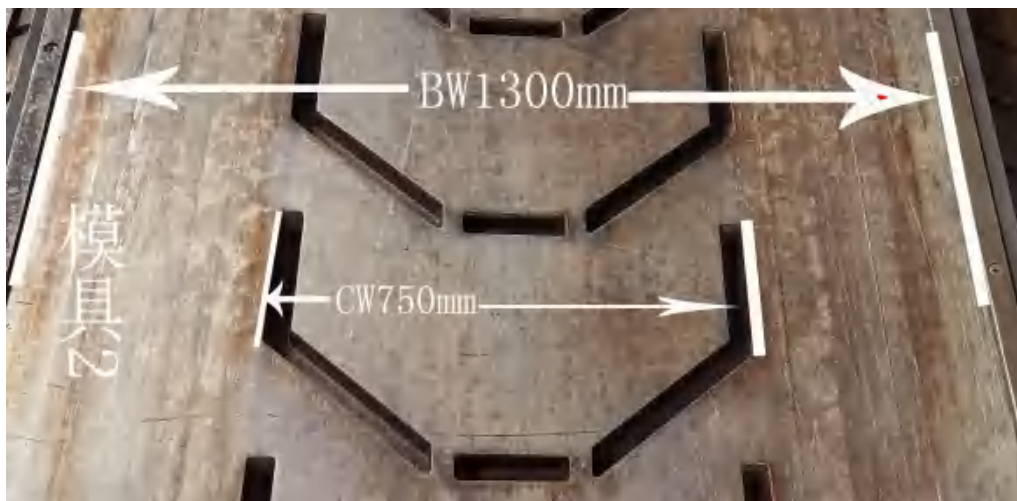
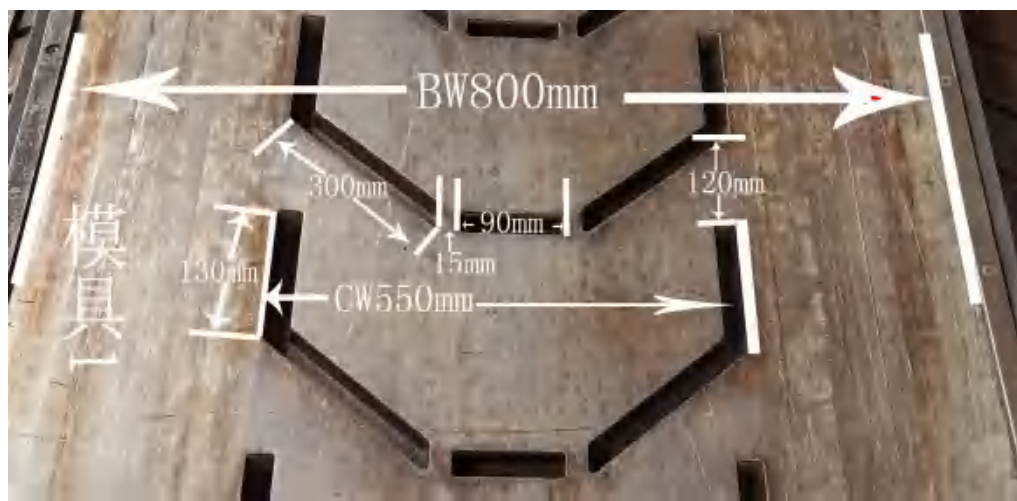

## 6 UT 型 25mm 花纹产品结构图

BW(mm) 带宽	CW(mm) 花纹宽	CP(mm) 花纹间距	PA(mm) 带边宽	CH(mm) 花纹高	DW(mm) 花纹上宽	EW(mm) 花纹下宽
800~1350	750	175	0~550	25	15	25

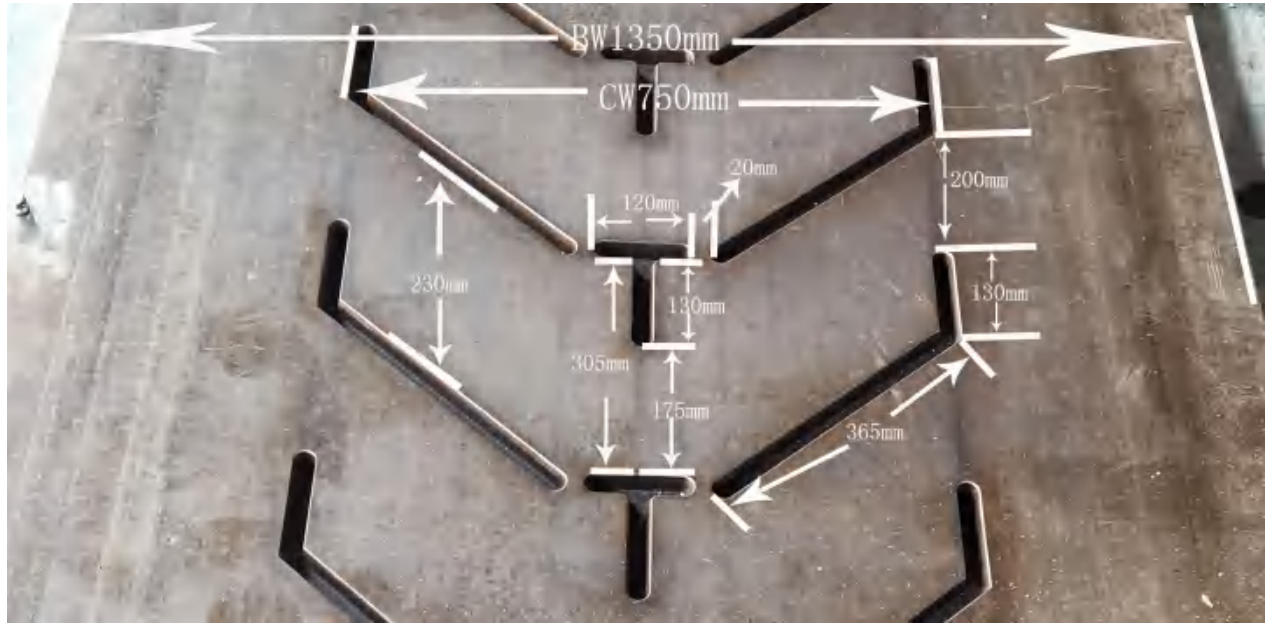

## 7 Y型 20mm 花纹产品结构图

BW(mm) 带宽	CW(mm) 花纹宽	CP(mm) 花纹间距	PA(mm) 带边宽	CH(mm) 花纹高	DW(mm) 花纹上宽	EW(mm) 花纹下宽	模具 1
600~800	500	175	0~550	20	15	25	
BW(mm) 带宽	CW(mm) 花纹宽	CP(mm) 花纹间距	PA(mm) 带边宽	CH(mm) 花纹高	DW(mm) 花纹上宽	模具宽 mm	模具 1
	750			32		1500	

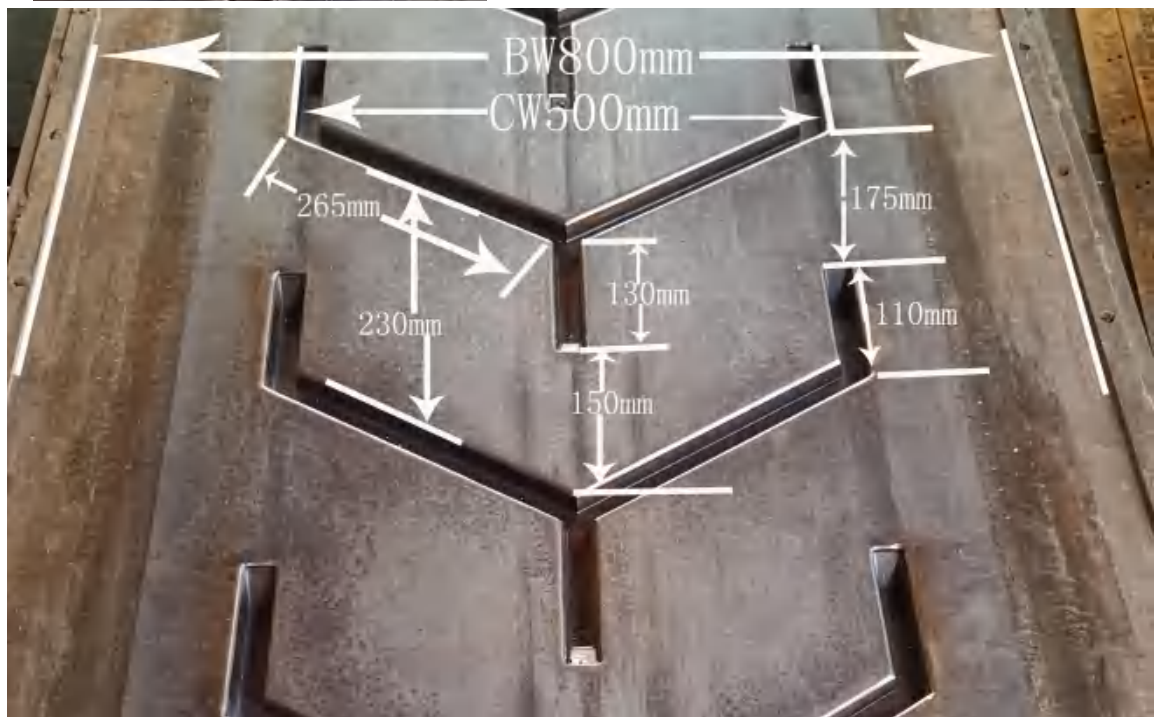

## 8 HY 型 15mm 花纹产品结构图

BW(mm) 带宽	CW(mm) 花纹宽	CP(mm) 花纹间距	PA(mm) 带边宽	CH(mm) 花纹高	DW(mm) 花纹上宽	EW(mm) 花纹下宽	模具 1
400~700	425	250	0~300	15	10	15	

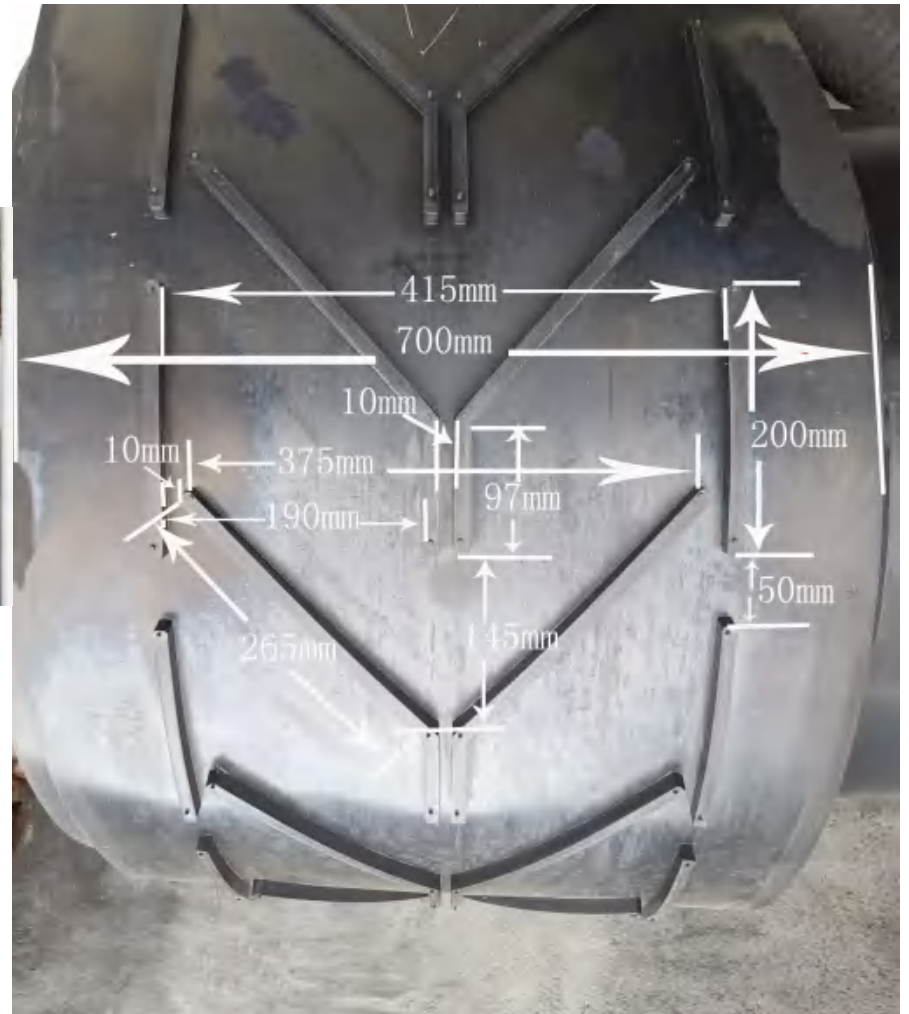

# 9

## UY 型 17mm 花纹产品结构图

BW(mm) 带宽	CW(mm) 花纹宽	CP(mm) 花纹间距	PA(mm) 带边宽	CH(mm) 花纹高	DW(mm) 花纹上宽	EW(mm) 花纹下宽	模具 1
500-650	440	230		17	10	17	
BW(mm) 带宽	CW(mm) 花纹宽	CP(mm) 花纹间距	PA(mm) 带边宽	CH(mm) 花纹高	DW(mm) 花纹上宽	EW(mm) 花纹下宽	模具 2
650-900	630	185		17	15	17	
BW(mm) 带宽	CW(mm) 花纹宽	CP(mm) 花纹间距	PA(mm) 带边宽	CH(mm) 花纹高	DW(mm) 花纹上宽	EW(mm) 花纹下宽	模具 2
1000-1200	950	46		17	15	17	

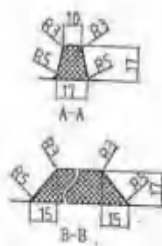
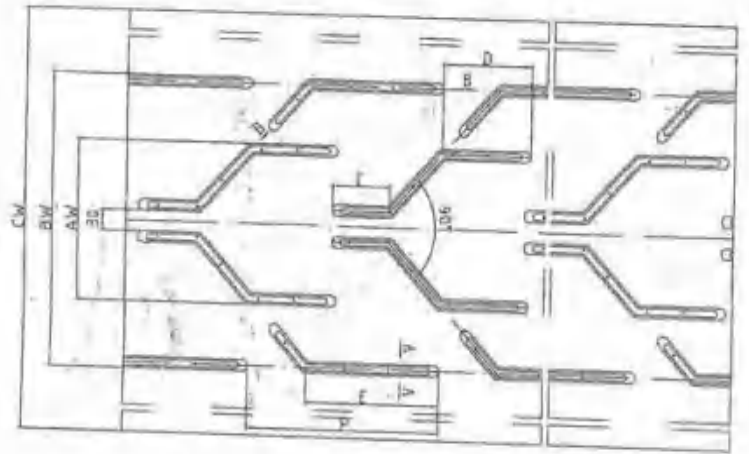

单位: mm

(板带宽) CW	BW	AW	C	D	E	P	模具长度	花纹编号
500-650	440	220	213.5	252	220	330	4米	板底
500-650	440	240	100	150	230	330	4米	L17P440
550-900	630	340	146	192	185	330	4米	L17P630
1000-1200	950	380	133.5	172	46	330	5.7米	L17P950
↓	1200							

# 10 多 V 型花纹产品结构图

BW(mm) 带宽	CW(mm) 花纹宽	CP(mm) 花纹间距	PA(mm) 带边宽	CH(mm) 花纹高	DW(mm) 花纹上宽	COLUMN V 列数	模具 1
500-1600	1550	65	0~25	6	8	10	
BW(mm) 带宽	CW(mm) 花纹宽	CP(mm) 花纹间距	PA(mm) 带边宽	CH(mm) 花纹高	DW(mm) 花纹上宽	COLUMN V 列数	模具 2
500-1400	1360	65		5	8	10	



# 11 连 V 型花纹产品结构图

BW(mm) 带宽	CW(mm) 花纹宽	CP(mm) 花纹间距	PA(mm) 带边宽	CH(mm) 花纹高	V Width V 宽	模具长 mm	模具 1
500-1350	1350	17	0	2	55	2300	
BW(mm) 带宽	CW(mm) 花纹宽	CP(mm) 花纹间距	PA(mm) 带边宽	CH(mm) 花纹高		模具长 mm	模具 2
500-1300	1300	18	0	3		2300	

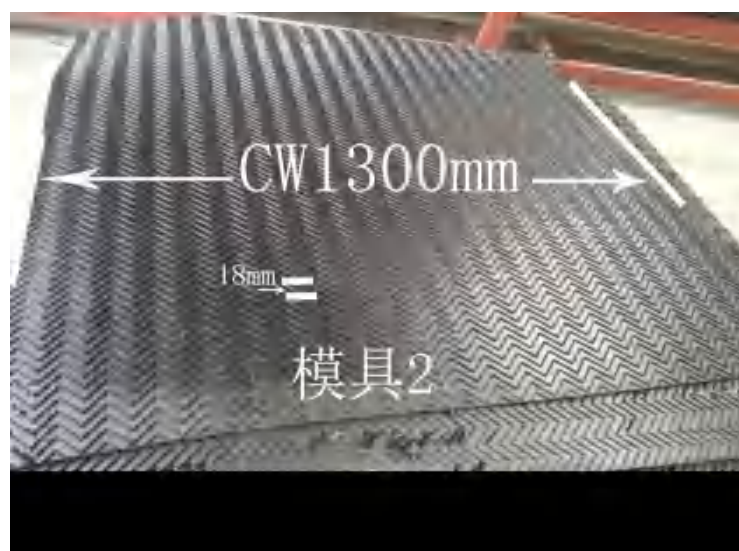
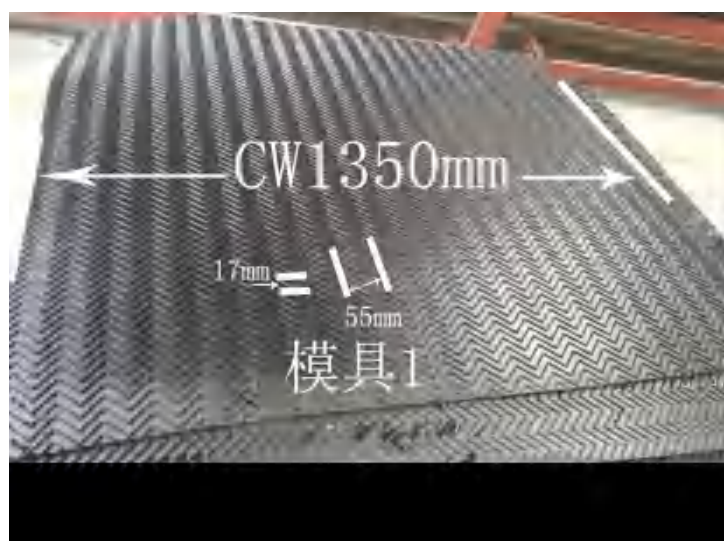

# 12

## 圆点型花纹产品结构图

BW(mm) 带宽	CW(mm) 花纹宽	CP(mm) 花纹间距	PA(mm) 带边宽	CH(mm) 花纹高	DW(mm) 花纹上宽	◎ Width ◎宽	模具 1
600-850	590	50	190	8		30	
BW(mm) 带宽	CW(mm) 花纹宽	CP(mm) 花纹间距	PA(mm) 带边宽	CH(mm) 花纹高	DW(mm) 花纹上宽	◎ mm ◎直径	模具 2
690-900	690	18	0	3.5		22	
BW(mm) 带宽	CW(mm) 花纹宽	CP(mm) 花纹间距	PA(mm) 带边宽	CH(mm) 花纹高	DW(mm) 花纹上宽	◎ mm ◎直径	模具 3
690-700	690	80	0	5			

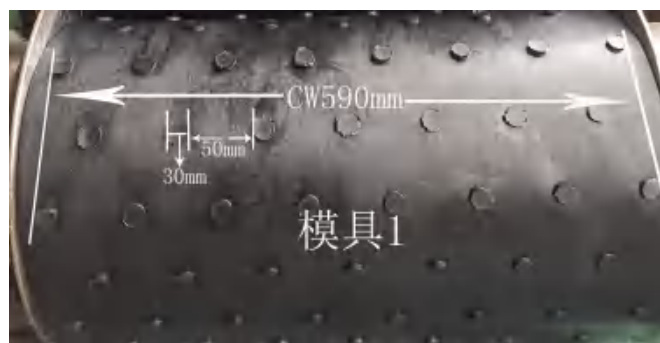

# 13

## 一字型花纹产品结构图

BW(mm) 带宽	CW(mm) 花纹宽	CP(mm) 花纹间距	PA(mm) 带边宽	CH(mm) 花纹高	DW(mm) 花纹上宽	模具宽 mm	模具 1
400-700	700	400	0	15		800	
BW(mm) 带宽	CW(mm) 花纹宽	CP(mm) 花纹间距	PA(mm) 带边宽	CH(mm) 花纹高	DW(mm) 花纹上宽	模具宽 mm	模具 2
500-800	475	330	0-162	30		900	
BW(mm) 带宽	CW(mm) 花纹宽	CP(mm) 花纹间距	PA(mm) 带边宽	CH(mm) 花纹高	DW(mm) 花纹上宽	模具宽 mm	模具 3
550-900	530	753	0-140	45	18	1000	
BW(mm) 带宽	CW(mm) 花纹宽	CP(mm) 花纹间距	PA(mm) 带边宽	CH(mm) 花纹高	DW(mm) 花纹上宽	模具宽 mm	模具 4
1000	1000		0	10		1000	

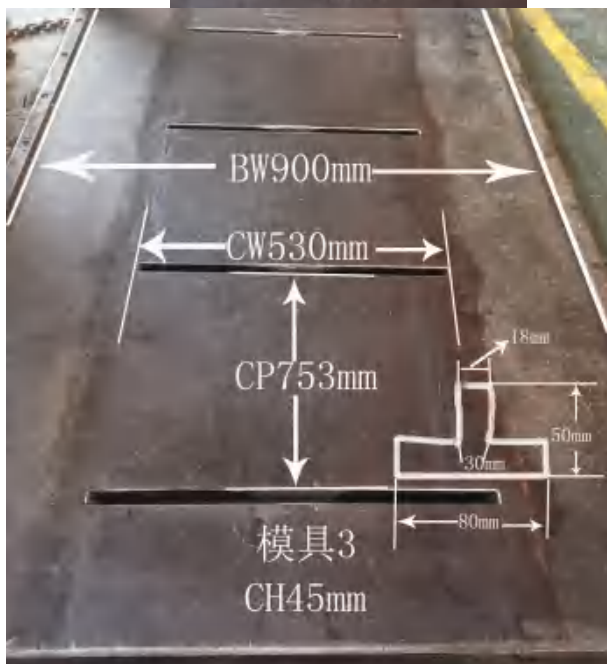
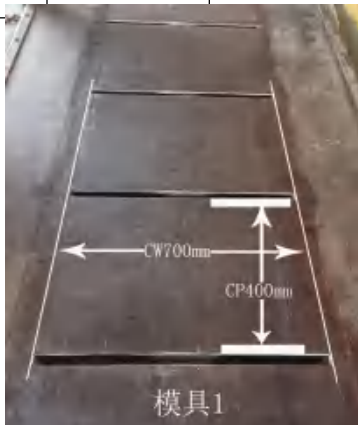

# 14

## 斜型花纹产品结构图

BW(mm) 带宽	CW(mm) 花纹长	CP(mm) 花纹间距	PA(mm) 带边宽	CH(mm) 花纹高	DW(mm) 花纹上宽	模具宽 mm	模具 1
800	830	55	0	9	10	910	



## 15 交叉型花纹产品结构图

BW(mm) 带宽	CW(mm) 花纹宽	CP(mm) 花纹间距	PA(mm) 带边宽	CH(mm) 花纹高	DW(mm) 花纹上宽	模具宽 mm	模具 1
650-700	650	250	0-50	13	10	800	

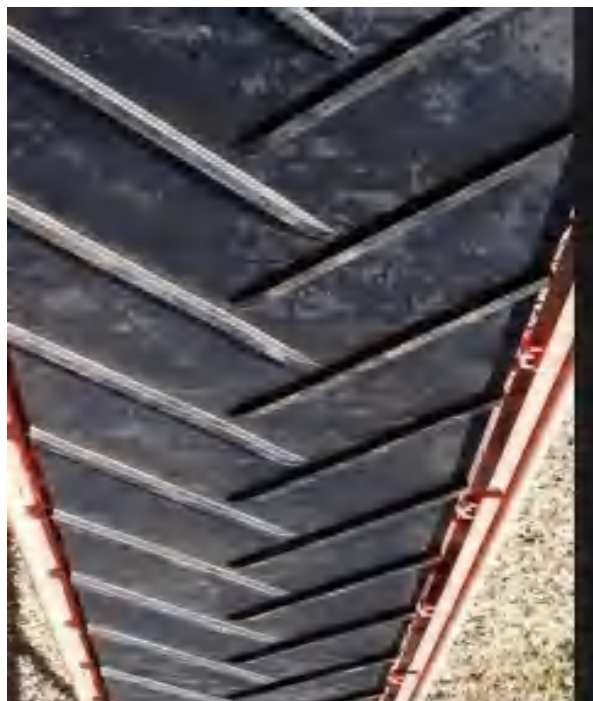

# 16

## 菱形花纹产品结构图

BW(mm) 带宽	CW(mm) 花纹宽	CP(mm) 花纹间距	PA(mm) 带边宽	CH(mm) 花纹高	DW(mm) 花纹上宽	模具宽 mm	模具 1
	480		0-210			1000	
BW(mm) 带宽	CW(mm) 花纹宽	CP(mm) 花纹间距	PA(mm) 带边宽	CH(mm) 花纹高	DW(mm) 花纹上宽	模具宽 mm	模具 2
	1000		0			1000	

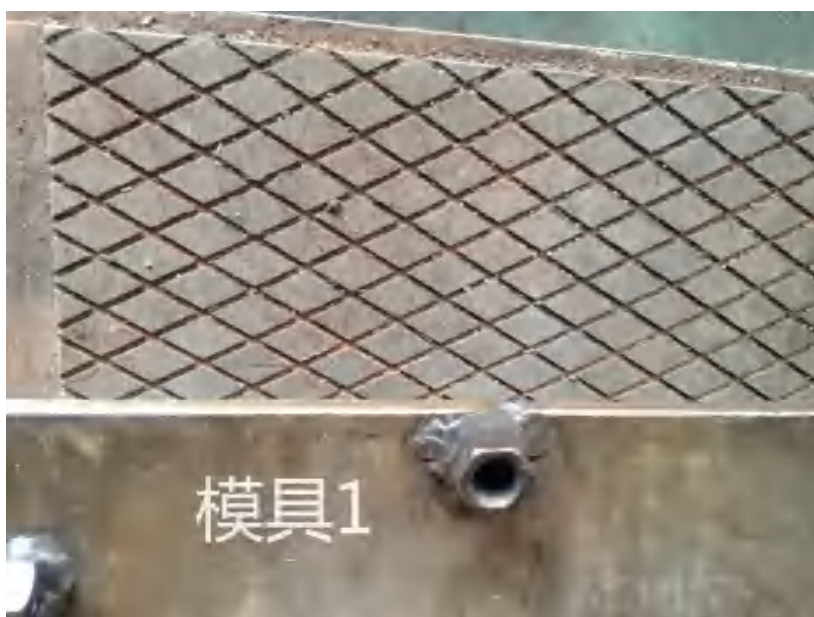

# 17

## 圆弧形花纹产品结构图

BW(mm) 带宽	CW(mm) 花纹宽	CP(mm) 花纹间距	PA(mm) 带边宽	CH(mm) 花纹高	DW(mm) 花纹上宽	模具宽 mm	模具 1
500-1000	490	90	0-255	35		1100	

